



Series 3585

Application and Installation Guide

Two-Way, Two Position, Normally Closed



Position 1) Coil De-energized. Pressure inlet port (1) is closed to outlet port (2).

Position 2) Coil Energized. Pressure inlet port (1) is open to outlet port (2).

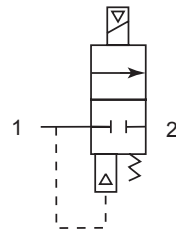
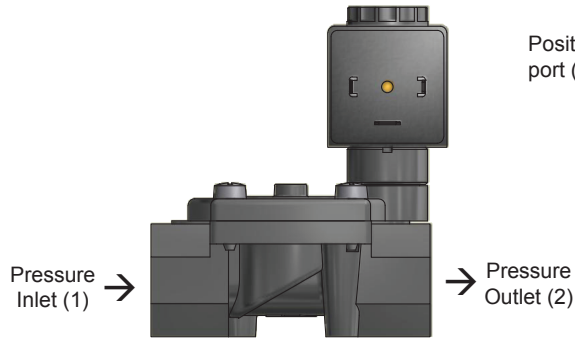

NOTE: Particulate Screen - 50 Mesh Stainless Steel



Series 3585

Application and Installation Guide

Two-Way, Two Position, Normally Closed



Position 1) Coil De-energized. Pressure inlet port (1) is closed to outlet port (2).

Position 2) Coil Energized. Pressure inlet port (1) is open to outlet port (2).

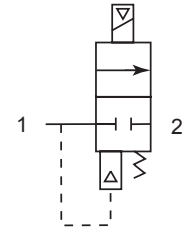
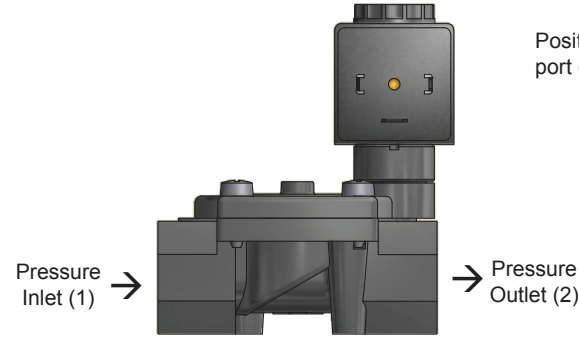

NOTE: Particulate Screen - 50 Mesh Stainless Steel

Two-Way, Two Position, Normally Open



Position 1) Coil De-energized. Pressure inlet port (1) is connected to outlet port (2).

Position 2) Coil Energized. Pressure inlet port (1) is closed to outlet port (2).

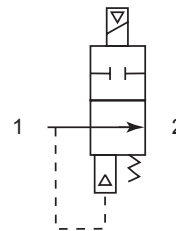
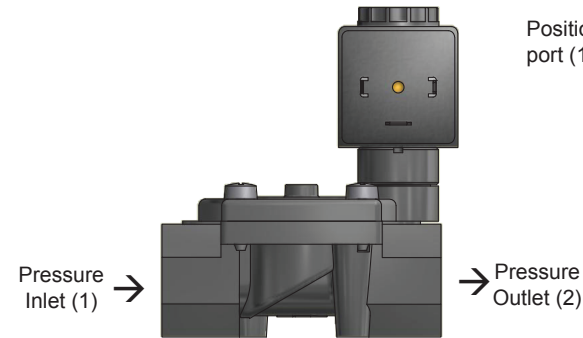

NOTE: Particulate Screen - 50 Mesh Stainless Steel

Two-Way, Two Position, Normally Open



Position 1) Coil De-energized. Pressure inlet port (1) is connected to outlet port (2).

Position 2) Coil Energized. Pressure inlet port (1) is closed to outlet port (2).

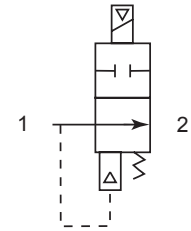
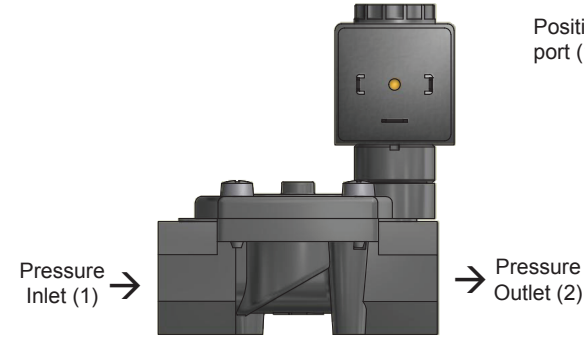

NOTE: Particulate Screen - 50 Mesh Stainless Steel



Series 3585

Application and Installation Guide

Electrical Hook-up

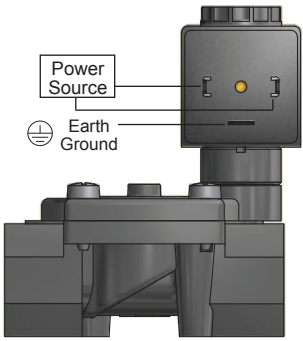

DIN Connector
Power leads connected to vertical pins on all versions. Horizontal pin is earth ground on all versions.

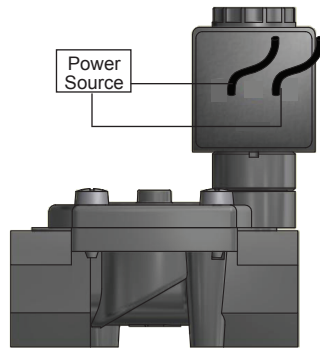

Flying Lead
Power leads connected to coil flying leads. No earth ground present.

Mounting Diagram

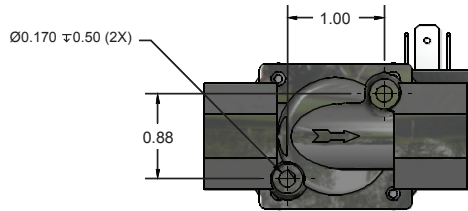

Mount on pipe in any position or #10 self tapping screw.

Caution

Excessive use of pipe sealant can cause clogging and leakage. Please follow ASME standards for applying pipe sealant and tape. Do not use media, voltage or pressures other than that recommended by Spartan Scientific Inc. as valve malfunction could result. Misuse or misapplication of Spartan solenoid valves could cause serious bodily injury or property damage.

Warranty Information

Solenoid valves and all other products manufactured by Spartan are warranted by Spartan to be free from defects in material and workmanship for a period of 1 year from the date of purchase. Spartan's obligation under this warranty is limited to repair or replacement of the defective product or refund of the purchase price paid solely at the discretion of Spartan and provided such defective product is returned to Spartan freight prepaid and upon examination by Spartan such product is found defective. This warranty shall be void in the event that the product has been subject to misuse, misapplication, improper maintenance, modification or tampering. This warranty is expressed in lieu of all other warranties, expressed or implied from Spartan Scientific, Inc., representatives or employees.



Series 3585

Application and Installation Guide

Electrical Hook-up

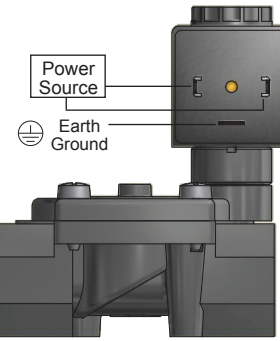

DIN Connector
Power leads connected to vertical pins on all versions. Horizontal pin is earth ground on all versions.

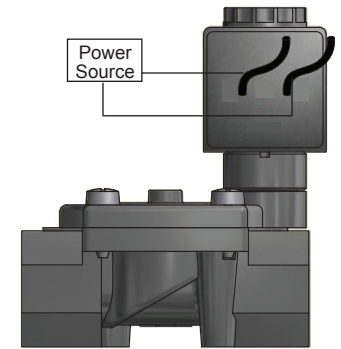

Flying Lead
Power leads connected to coil flying leads. No earth ground present.

Mounting Diagram

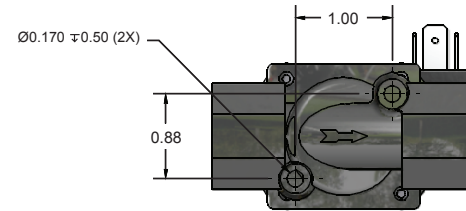

Mount on pipe in any position or #10 self tapping screw.

Caution

Excessive use of pipe sealant can cause clogging and leakage. Please follow ASME standards for applying pipe sealant and tape. Do not use media, voltage or pressures other than that recommended by Spartan Scientific Inc. as valve malfunction could result. Misuse or misapplication of Spartan solenoid valves could cause serious bodily injury or property damage.

Warranty Information

Solenoid valves and all other products manufactured by Spartan are warranted by Spartan to be free from defects in material and workmanship for a period of 1 year from the date of purchase. Spartan's obligation under this warranty is limited to repair or replacement of the defective product or refund of the purchase price paid solely at the discretion of Spartan and provided such defective product is returned to Spartan freight prepaid and upon examination by Spartan such product is found defective. This warranty shall be void in the event that the product has been subject to misuse, misapplication, improper maintenance, modification or tampering. This warranty is expressed in lieu of all other warranties, expressed or implied from Spartan Scientific, Inc., representatives or employees.